

All Ranch Reining

Ranch Horse Reining Pattern #3

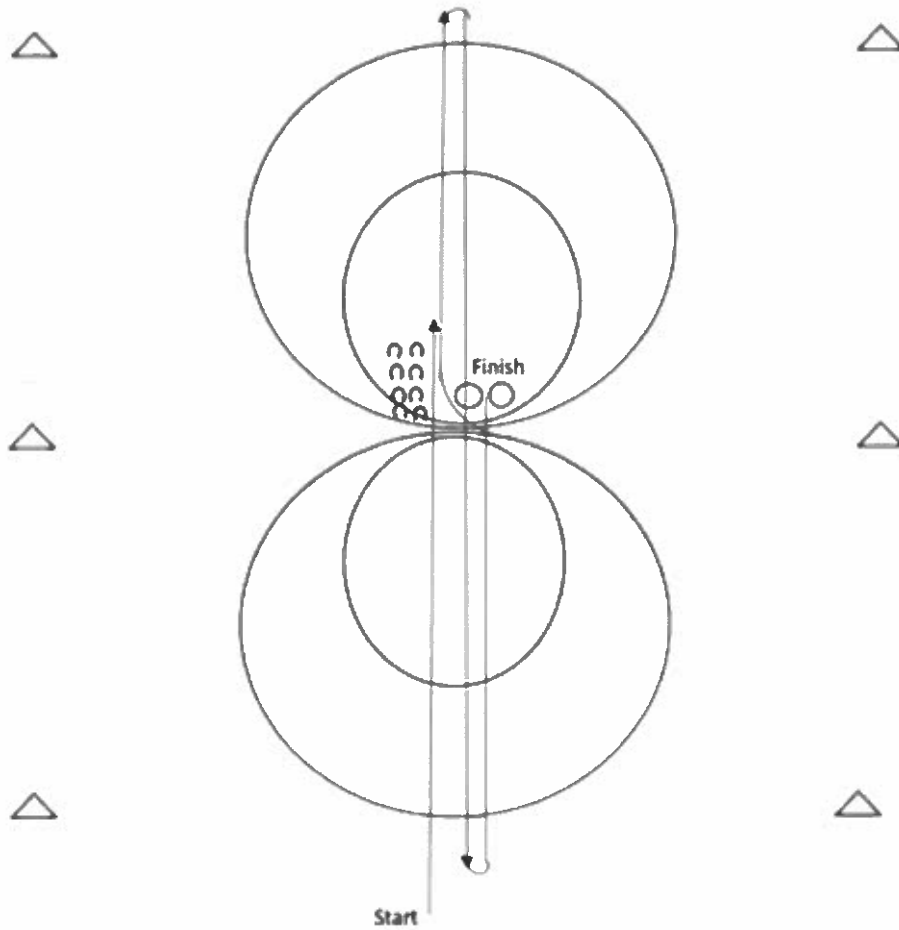

1. Run past the center marker, stop, back 10 feet, $\frac{1}{4}$ turn to left.
2. Beginning on the right lead complete one small slow circle to the right, Change leads at the center of arena.
3. Complete one small slow circle to the left, Change leads in the center of the arena.
4. Begin large faster circle to right, Change leads in center of arena.
5. Complete large faster circle to the left, Change leads in center of arena
6. Run down center of arena past the end marker and do a right roll back, no hesitation.
7. Run up the middle to the other end of the arena past the end marker and do a left roll back, no hesitation.
8. Run up the middle to the center, stop, 1 spin to right, 1 spin to left. Hesitate to complete pattern.

RANCH TRAIL

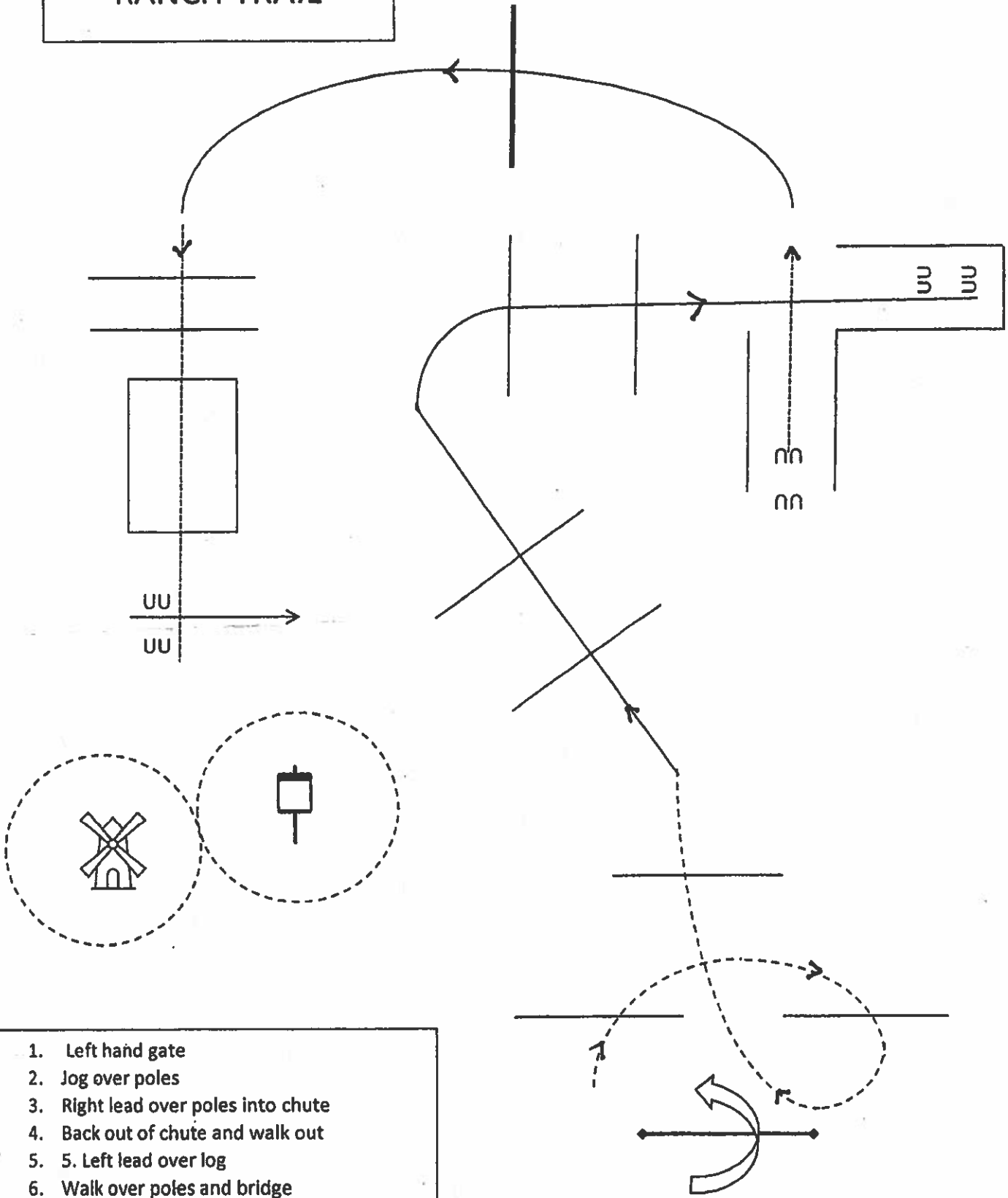

1. Left hand gate
2. Jog over poles
3. Right lead over poles into chute
4. Back out of chute and walk out
5. 5. Left lead over log
6. Walk over poles and bridge
7. Left side pass over last pole
8. Figure 8 at trot –
 Youth/Novice: Pick up slicker
 Open/Amateur: Drag

RANCH PLEASURE

PATTERN 5

- Lope – 150 feet
- Extended Lope – 200 feet
- Ordinary Walk – 30 feet
- Trot – 120 feet
- Stop and Reverse
- Extended Trot – 240 feet
- Trot – 90 feet
- Extended Walk – 75 feet
- Lope – 150 Feet
- Stop and Back

Texas APHA Hearts and Flowers Show

All Ranch Riding Classes

Show Date: February 14-17

www.HorseShowPatterns.com

www.HorseShowPatterns.com

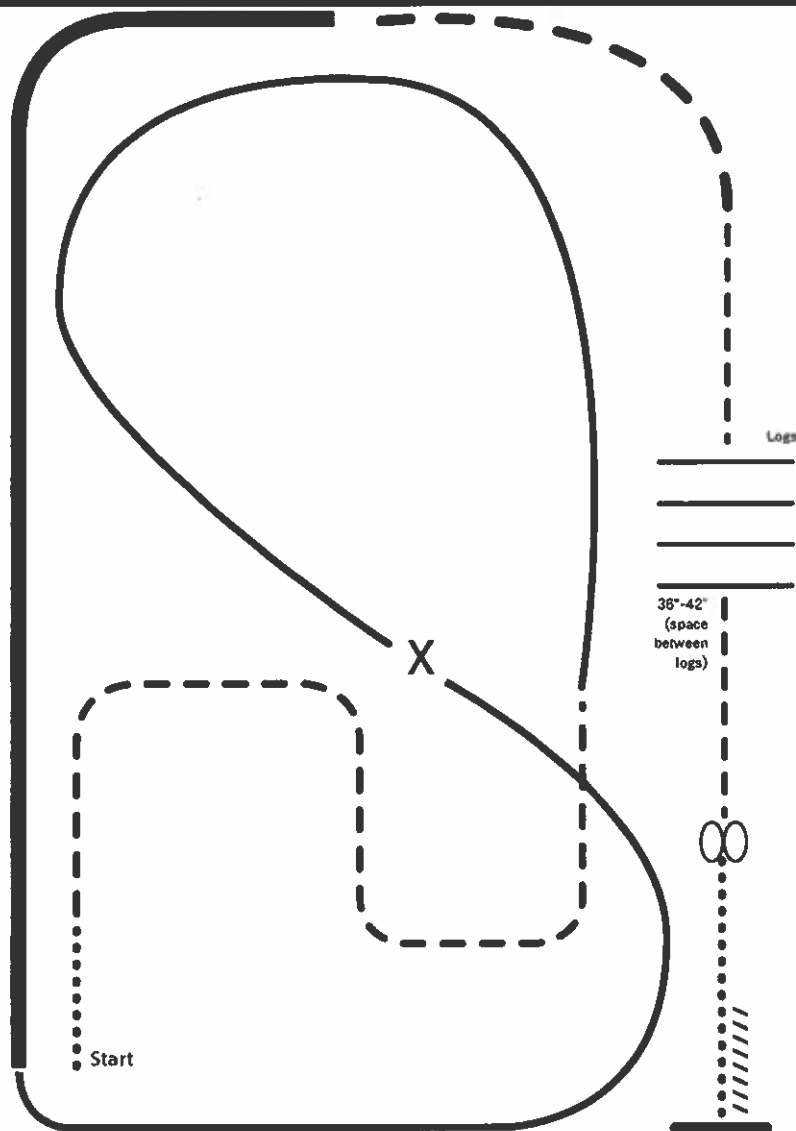

- X Lead Change
- Walk
- - - Trot
- Ext trot
- Lope
- Ext Lope
- //// Back

1. Walk
2. Trot serpentine
3. Lope left lead around the end of the arena and then diagonally across the arena
4. Change leads (simple or flying) and
5. Lope on the right lead around end of the arena
6. Extend lope on the straight away and around corner to the center of the arena
7. Extend trot around corner of the arena
8. Collect to a trot
9. Trot over logs
10. Stop, do 360 degree turn each direction (either direction 1st) (L-R or R-L)
11. Walk, stop and back

[RR/AQHA-3]

Pattern Provided by:



**Hearts & Flowers Horse Show
Waco, Texas**

**ALL WALK-JOG
TRAIL CLASSES**

CLASSES 80-89
FEBRUARY 16TH, 2024

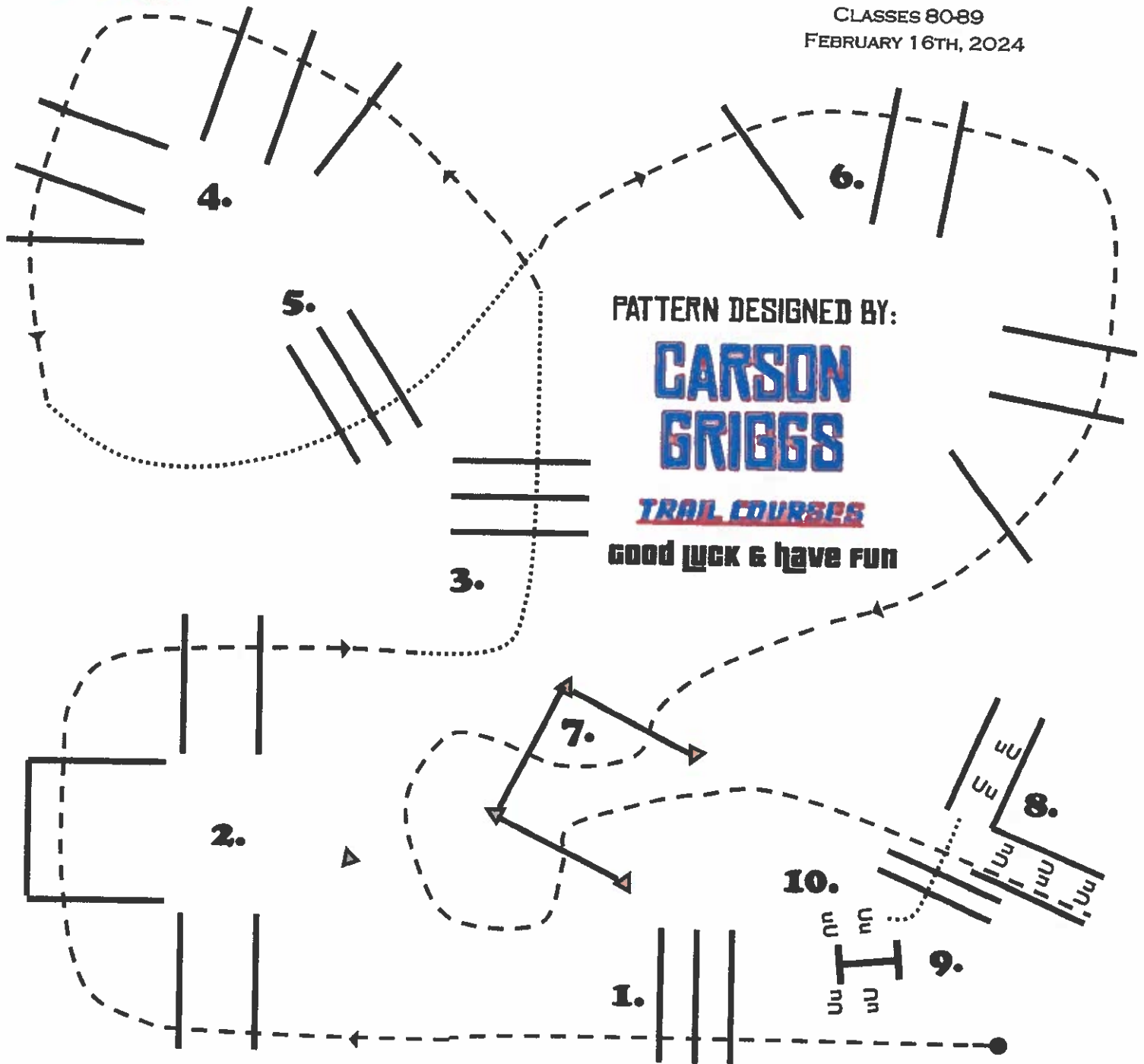

PATTERN DESIGNED BY:

**CARSON
GRIGGS**

TRAIL COURSES

GOOD LUCK & HAVE FUN

- 1. JOG OVER POLES
- 2. JOG OVER #2
- 3. WALK OVER POLES
- 4. JOG OVER #4
- 5. WALK OVER POLES

- 6. JOG OBSTACLE #6
- 7. JOG SERPENTINE AS SHOWN
- 8. BACK THE "L" CHUTE
- 9. WALK OVER POLES TO GATE
- 10. OPEN GATE ^{Left} RIGHT HAND



Hearts & Flowers Horse Show
Waco, Texas

TRAIL

CLASSES 70-79 & 90-97
 FEBRUARY 16TH, 2024

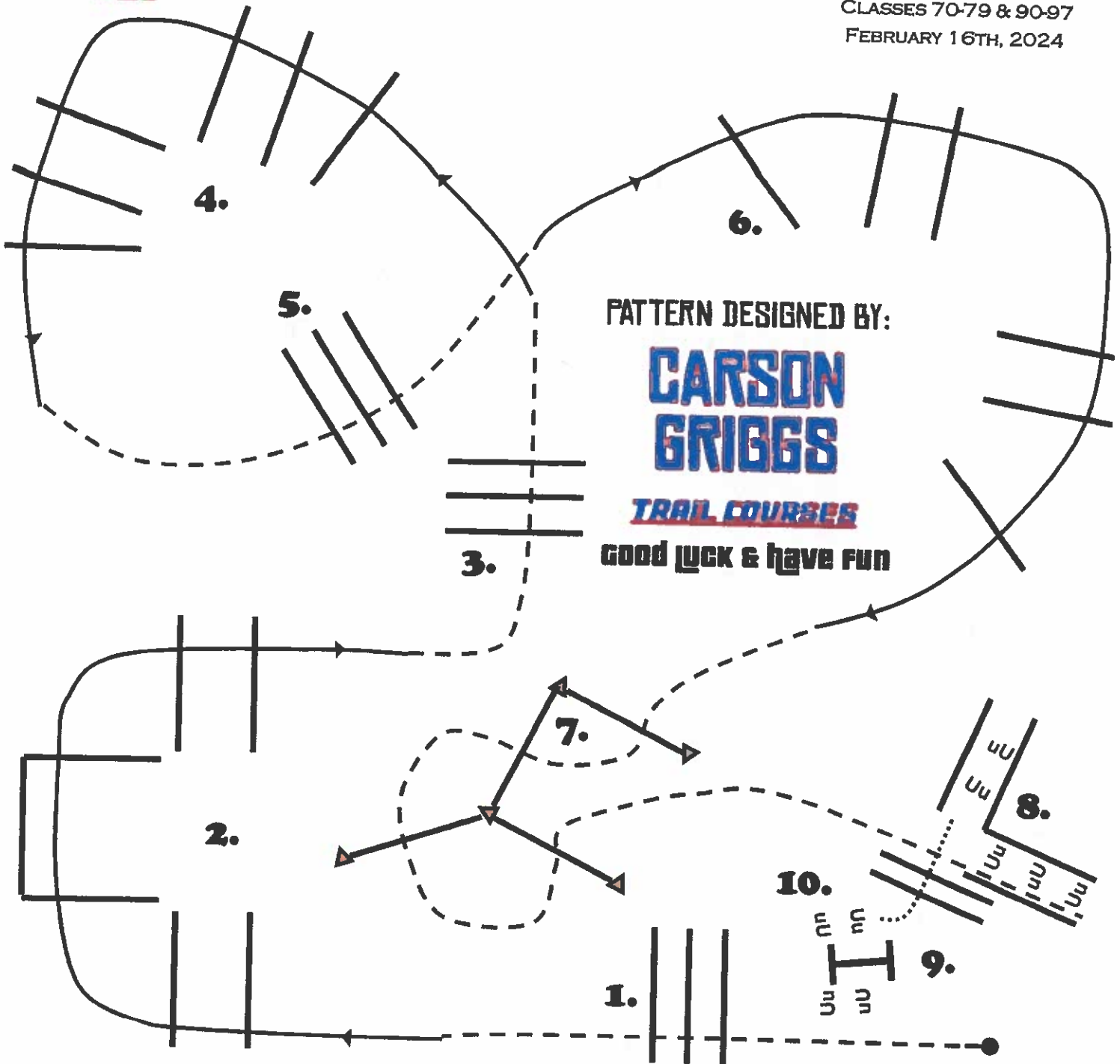

PATTERN DESIGNED BY:
CARSON GRIGGS
TRAIL COURSES
 GOOD LUCK & HAVE FUN

- 1. JOG OVER POLES
- 2. LOPE RIGHT LEAD #2
- 3. JOB OVER POLES
- 4. LOPE LEFT LEAD #4
- 5. JOG OVER POLES

- 6. LOPE OBSTACLE #6 RIGHT LEAD
- 7. JOG SERPENTINE AS SHOWN
- 8. BACK THE "L" CHUTE
- 9. WALK OVER POLES TO GATE
- 10. OPEN GATE ^{Left} ~~Right~~ HAND

Texas APHA Hearts and Flowers Show

All Walk-Trot Horsemanship

Show Date: February 14-17

W W W . H o r s e S h o w P a t t e r n s . c o m

W W W . H o r s e S h o w P a t t e r n s . c o m

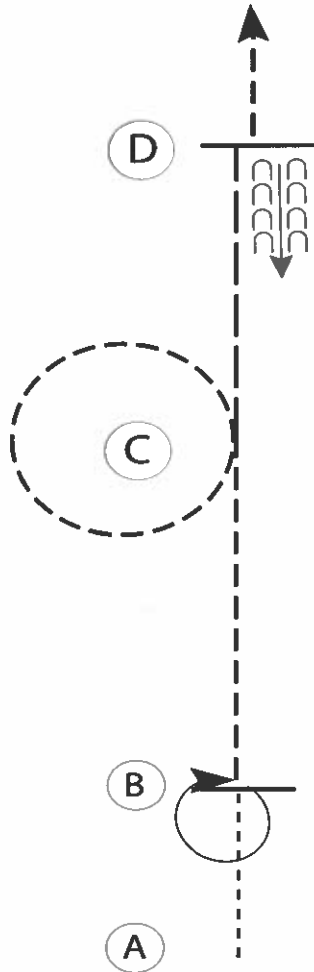

1. Walk from A to B
2. At B stop and perform a 360 degree turn on the hindquarters to the right
3. Jog to C, and jog a circle around C to the left
4. Extend the jog to D
5. At D stop, back five steps, and jog to the line

Walk	-----
Jog	- - - - -
Extended Jog	-----
Lope	—————
Leg Yield	
Lead Change	↘
Back	←←←←←
Marker	(B)
Sidepass	←-----←

[WH/WT-15]

Pattern Provided by:

Texas APHA Hearts and Flowers Show

13 & Under, Nov. Yth, Nov, Am. Horsemanship

Show Date: February 14-17

www.HorseShowPatterns.com

www.HorseShowPatterns.com

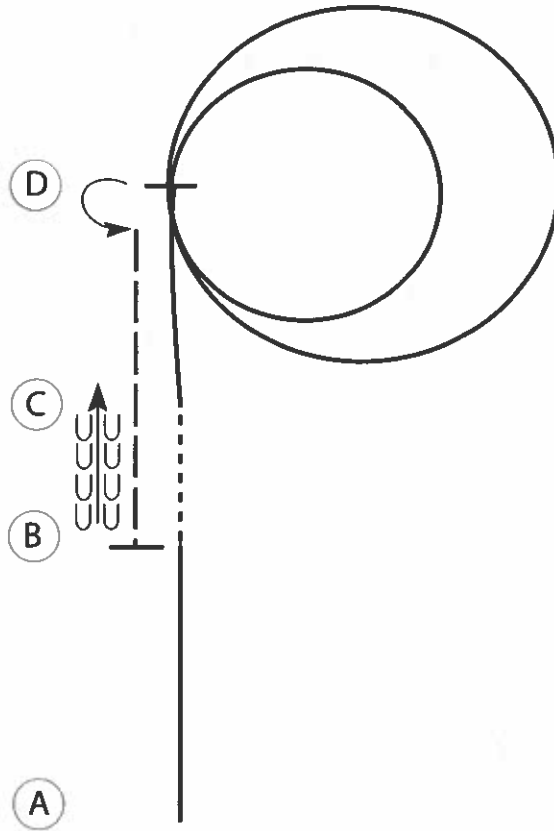

Be ready at A.

1. Lope on the left lead to B.
2. Walk B to C.
3. Lope on the right lead to D.
4. Lope a large fast circle to the right.
5. Lope a small slow circle to the right.
6. Stop at D and perform a 180 degree spin to the left.
7. Extend the jog to B.
8. Stop at B and back to C.

Follow the instructions of your ring steward.

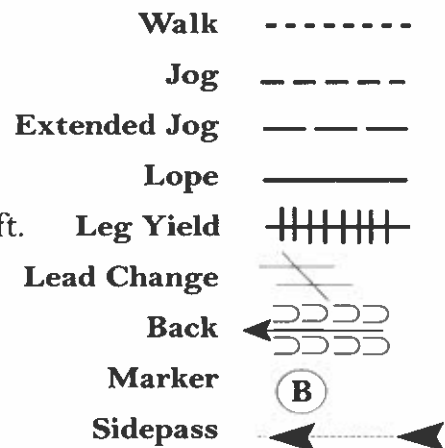

[WH/3-1]

Pattern Provided by:

Texas APHA Hearts and Flowers Show

Yth. 18 & Under, Amateur, & Am. Masters Horsemanship

Show Date: February 14-17

www.HorseShowPatterns.com

www.HorseShowPatterns.com

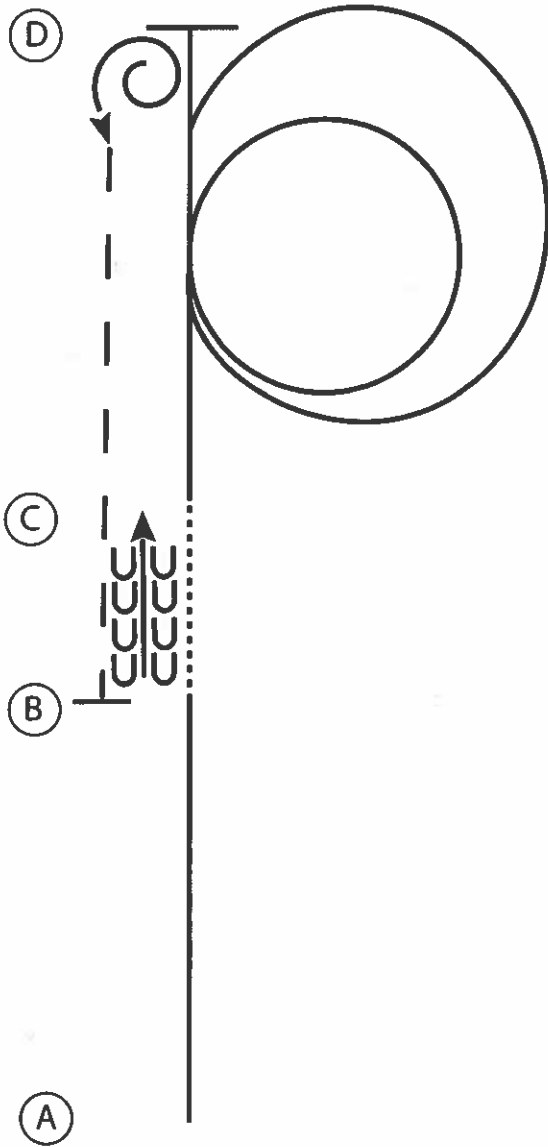

1. Lope A to B on the left lead
2. Walk B to C
3. At C lope on the right lead towards D
4. Before D lope a large fast circle to the right followed by a small slow circle to the right and continue to D
5. At D stop and perform a 540 degree turn to the left
6. Extend the jog to B
7. At B stop and back to C

Walk
Jog	-----
Extended Jog	-----
Lope	—————
Leg Yield	
Lead Change	↘
Back	← C C C C C C C C
Marker	ⓑ
Sidepass	←-----←

[WH/3-10]

Pattern Provided by:

Texas APHA Hearts and Flowers Show

Green, Nov. Yth. & Nov. Amateur Western Riding

Show Date: February 14-17

www.HorseShowPatterns.com

www.HorseShowPatterns.com

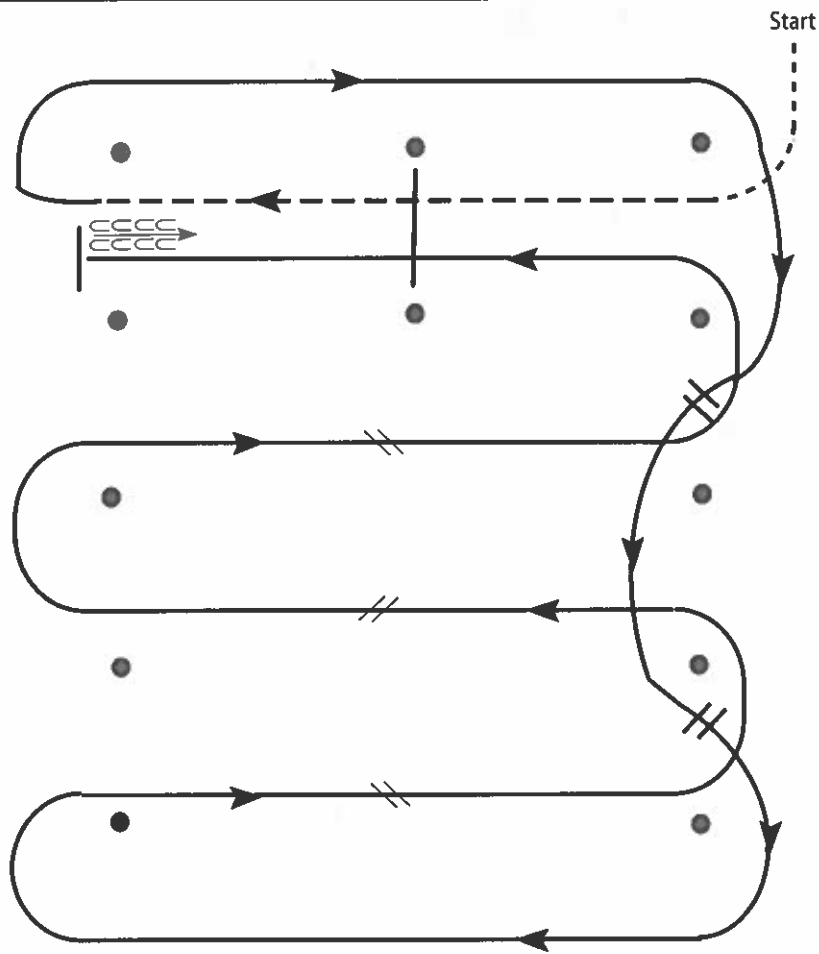

1. Walk, transition to jog, jog over log.
2. Transition to right lead and lope around end.
3. First line change.
4. Second line change. Lope around end of arena.
5. First crossing change.
6. Second crossing change.
7. Third crossing change.
8. Lope over log.
9. Lope, stop and back.

[WR/GP-4]

Pattern Provided by:

Texas APHA Hearts and Flowers Show

Open, Amateur, and Youth Western Riding

Show Date: February 14-17

www.HorseShowPatterns.com

www.HorseShowPatterns.com

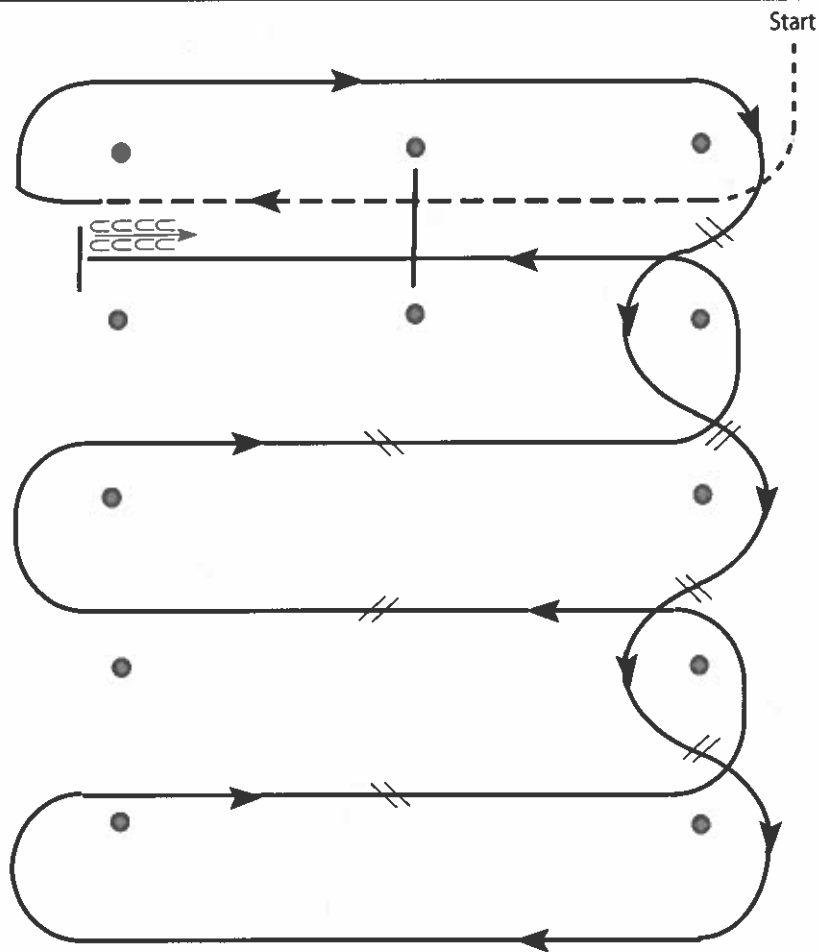

1. Walk, transition to jog, jog over log.
2. Transition to right.
3. First line change.
4. Second line change.
5. Third line change.
6. Fourth line change.
7. First crossing change.
8. Second crossing change.
9. Third crossing change.
10. Lope over log.
11. Lope, stop and back.

[WR/OP-4]

Pattern Provided by:

Texas APHA Hearts and Flowers Show

All WT, 13 & Un, Nov. Am, Nov. Yth Showmanship (AM WT Walk Only)

Show Date: February 14-17

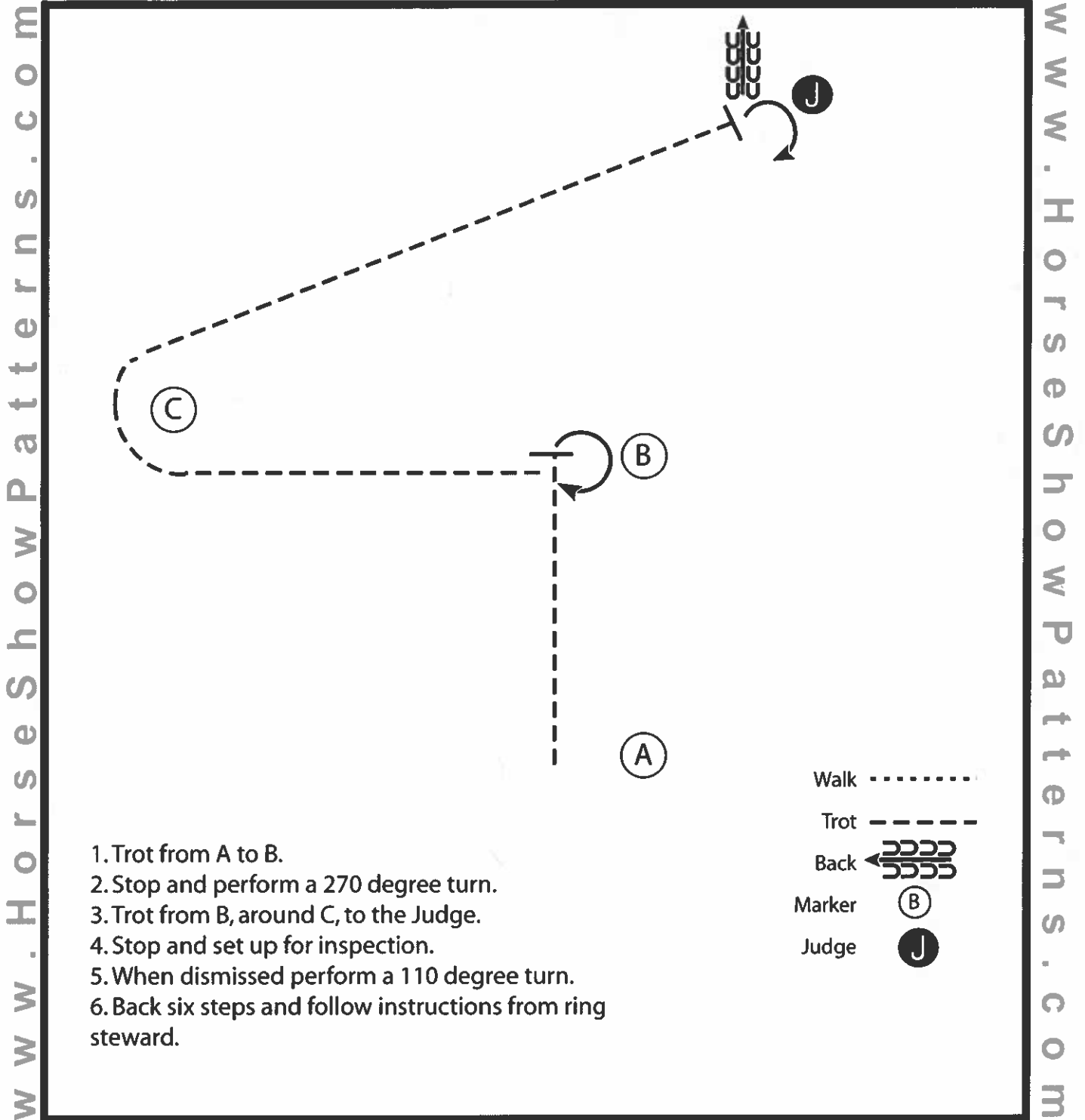

[S/2-11]

Pattern Provided by:

Texas APHA Hearts and Flowers Show

Yth 18 & Under, Am. & Masters Am. Showmanship

Show Date: February 14-17

www.HorseShowPatterns.com

www.HorseShowPatterns.com

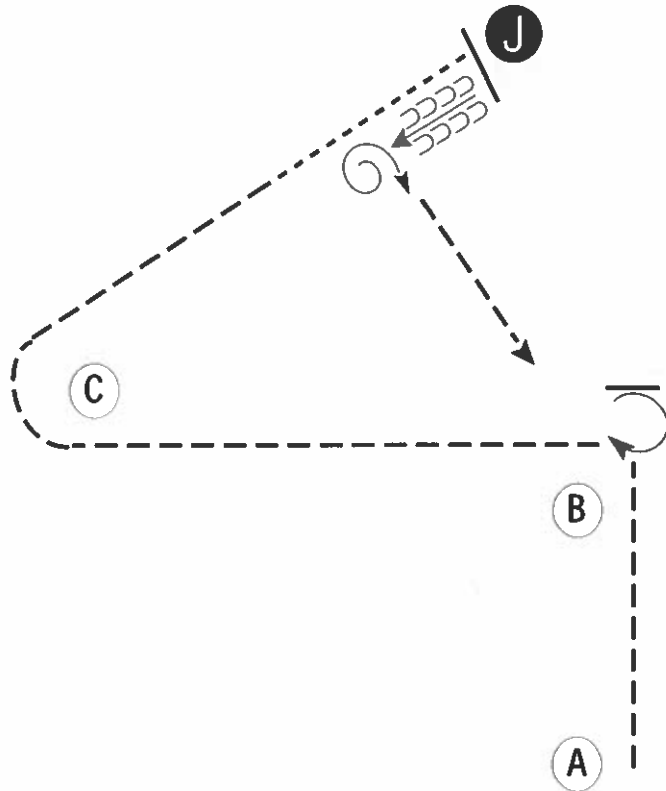

Be ready at A.

1. Trot from A past B.
2. Stop and perform 270 degree turn.
3. Trot around C. Break to a walk half way to the Judge.
4. Walk to Judge, stop and set up for inspection.
5. When dismissed back one horse length.
6. Perform a 450 degree turn and trot to the line-up or follow the instructions of your ring steward.

- Walk -----
- Trot _____
- Back ← [Backward Trotting Pattern]
- Marker (B)
- Judge (J)

[S/3-14]

Pattern Provided by:

Texas APHA Hearts and Flowers Show

Yth 13 & Under, Nov. Yth, Nov. Am., Am. Masters Hunt Seat Equ.

Show Date: February 14-17

W W W . H O R S E S H O W P A T T E R N S . C O M

W W W . H O R S E S H O W P A T T E R N S . C O M

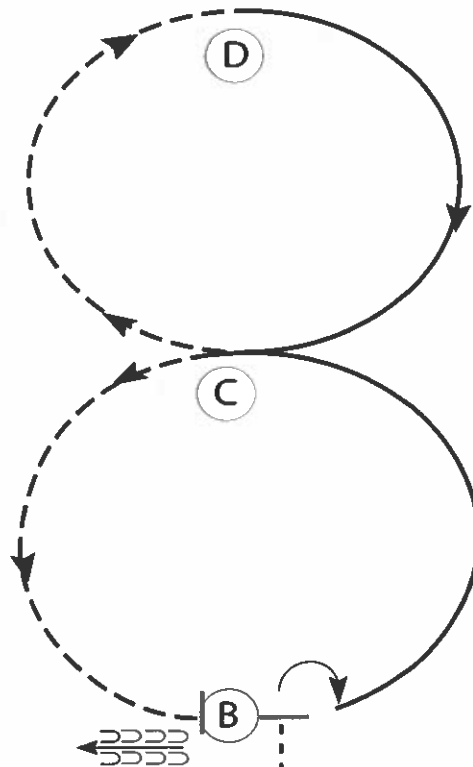

Be ready at A.

1. Walk to B.
2. Stop at B and perform a 90 degree turn to the right on the forehand.
3. Canter on the left lead to C.
4. Posting trot from C to D.
5. Canter on the right lead from D to C.
6. Posting trot from C to B.
7. Stop at B and back one horse length.

Follow the instructions of your ring steward.

Walk	-----
Trot	- - - - -
Extended Trot	—————
Canter	—————
Leg Yield	
Lead Change	↘ ↙
Back	← ← ← ← ←
Marker	⊙ B
Sidepass	← ← ← ← ←
Hand Gallop	—————

[HSE/2-13]

Pattern Provided by:

Texas APHA Hearts and Flowers Show

Yth 18 & Under & Amateur Hunt Seat Equitation

Show Date: February 14-17

www.HorseShowPatterns.com

www.HorseShowPatterns.com

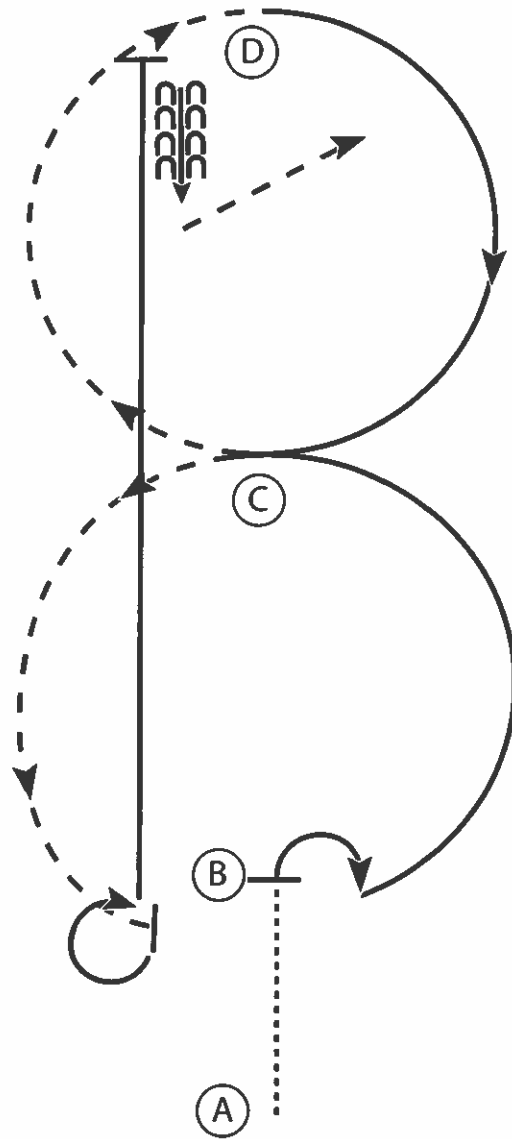

1. Walk A to B
2. At B stop and perform a 90 degree turn to the right on the haunches
3. Canter on the left lead in a half circle to C
4. At C posting trot in a half circle to D on the left diagonal
5. At D counter canter on the left lead in a half circle to C
6. At C posting trot a half circle to before B on the right diagonal
7. Before B stop and perform a 270 degree turn to the right
8. Hand gallop to D
9. At D stop and back 4 steps
10. Sitting trot to exit

Walk
Trot	- - - - -
Extended Trot	— — — — —
Canter	—————
Leg Yield	
Lead Change	— / —
Back	← ← ← ← ←
Marker	Ⓚ
Sidepass	← - - - - ←

[HSE/3-16]

Pattern Provided by:

Texas APHA Hearts and Flowers Show

All Walk-Trot Hunt Seat Equitation

Show Date: February 14-17

www.HorseShowPatterns.com

www.HorseShowPatterns.com

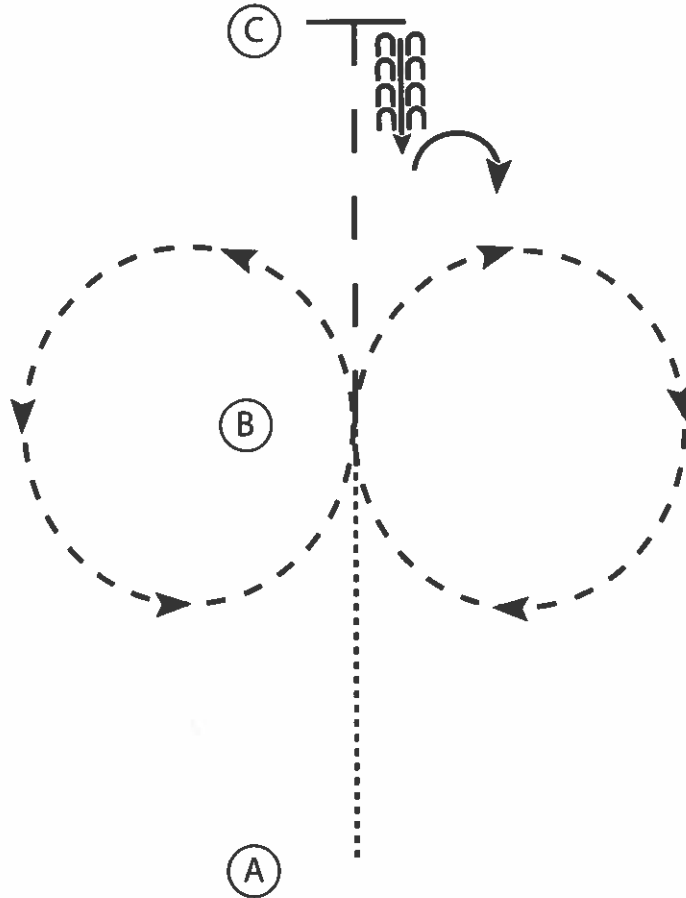

1. Walk A to B
2. Sitting trot circle to the right
3. Posting trot circle to the left
4. At B extend the trot to C
5. Stop at C and back 4 steps
6. Perform a 90 degree turn to the right

Walk
Trot	-----
Extended Trot	-----
Canter	—————
Leg Yield	
Lead Change	↘
Back	←←←←
Marker	(B)
Sidepass	←-----←

[HSE/WT-1]

Pattern Provided by: